

# 东莞市联佳电子塑胶制品有限公司

TEL:0769-86639029

FAX:0769-86639039

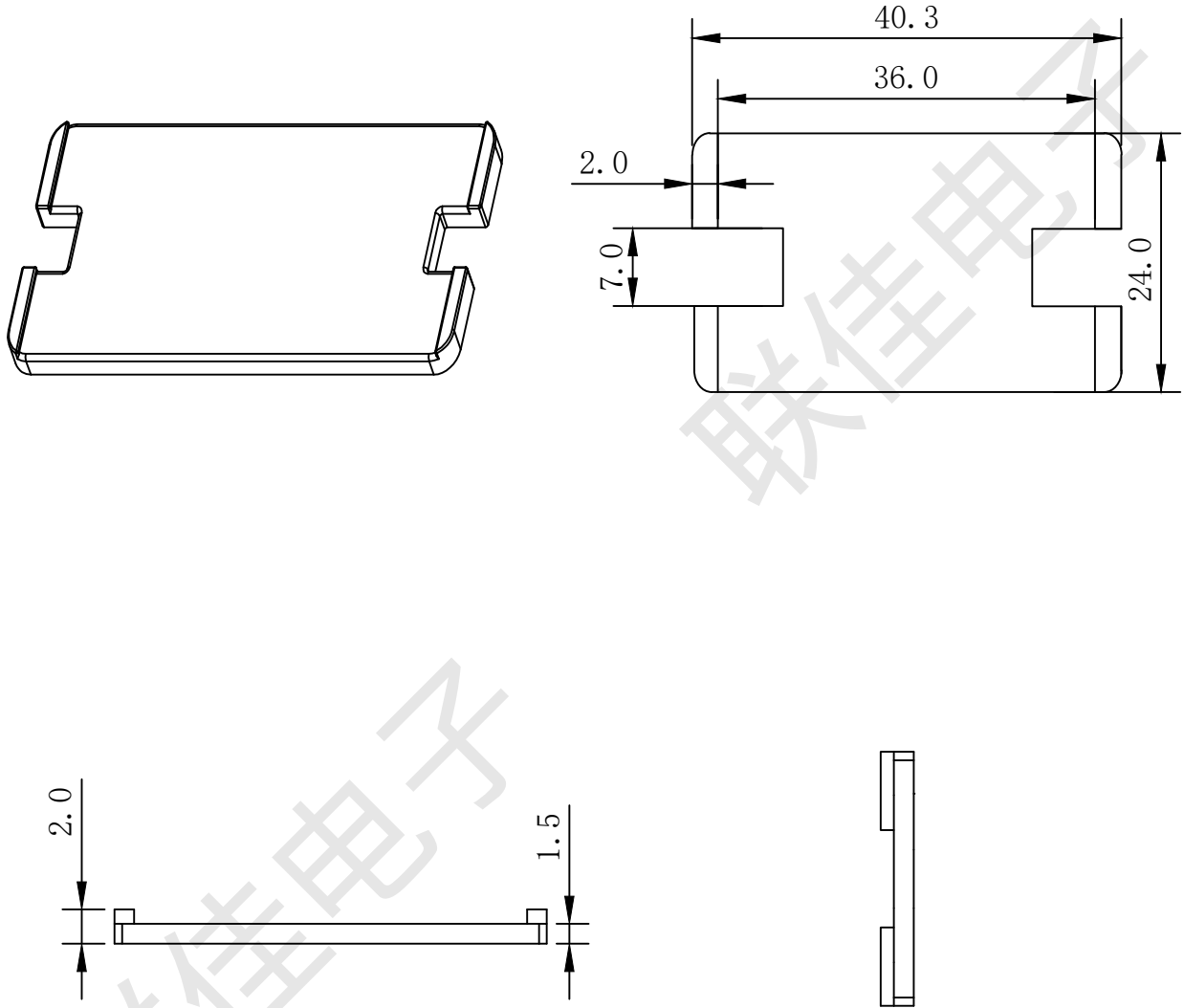

编号: 4402401D1	SCALE:	TDLERANCE UNLESS OTHERWISE STATED	CHECK	
BOBBIN SIZE:40*24*1.5 防震垫片	UNIT:mm	0<L≤4 ±0.1	DRAW	
MATERIAL:PPS		4<L≤16 ±0.2	REV:	DRTE:
UL REC:UL94V-0	DRAWING:	16<L≤63 ±0.3	01	