

# 东莞市联佳电子塑胶制品有限公司

TEL:0769-6639029 FAX:0769-6639039

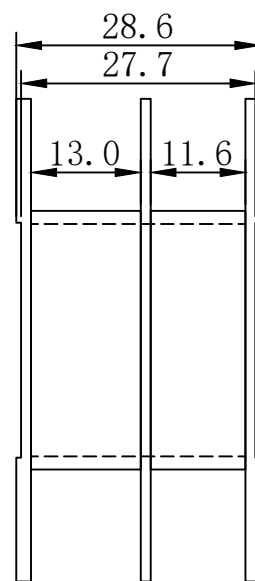
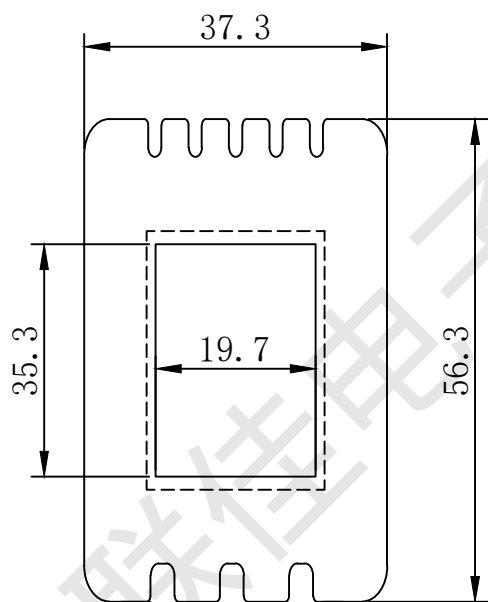
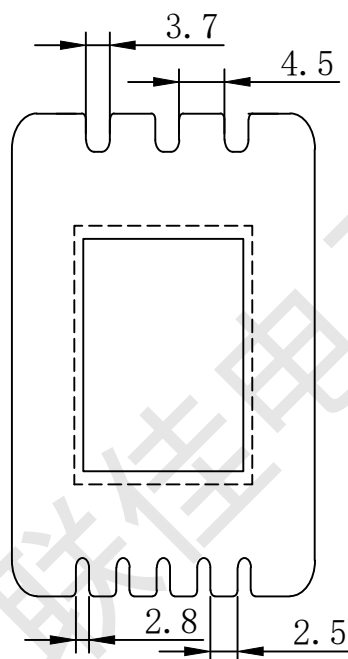
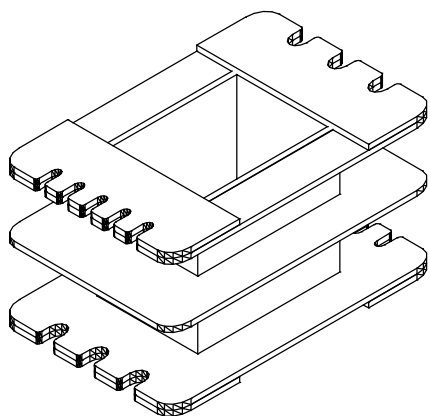

编号: 25735W01		SCALE:	TDLERANCE UNLESS ORHERWISE STATED	CHECK
BOBBIN SIZE:EI-57×35 王字		UNIT:mm	0<L≤4 ±0.1	DRAW
MATERIAL:PN			4<L≤16 ±0.2	REV:DRTE: 01
UL REC:UL94V-0		DRAWING:	16<L≤63 ±0.3	