

东莞市联佳电子塑胶制品有限公司

TEL:0769-86639029

FAX:0769-86639039

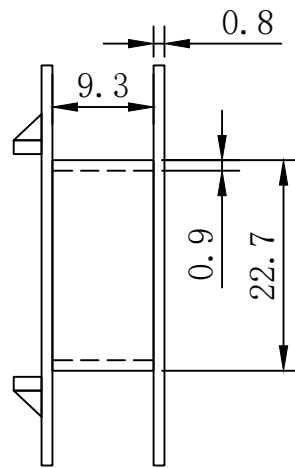
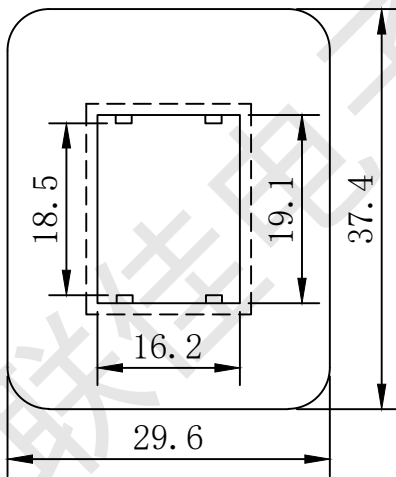
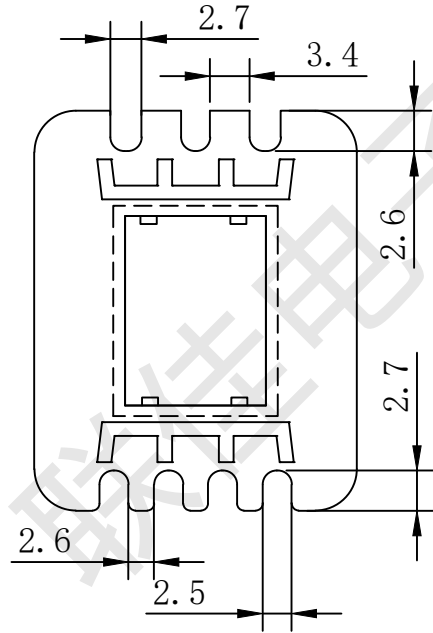
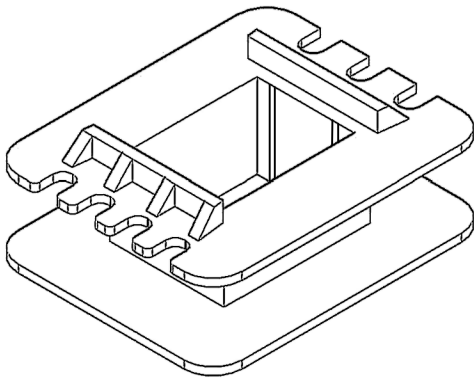

编号:14818X06

SCALE:

TDLERANCE UNLESS
ORHERWISE STATED

CHECK

BOBBIN SIZE:EI-48×18.6 加筋芯 3+4

UNIT:mm

0<L≤4 ±0.1
4<L≤16 ±0.2
16<L≤63 ±0.3

DRAW

MATERIAL:PA66

UL REC:UL94V-2

DRAWING:

REV: DRTE:
01