

东莞市联佳电子塑胶制品有限公司

TEL:0769-86639029 FAX:0769-86639039

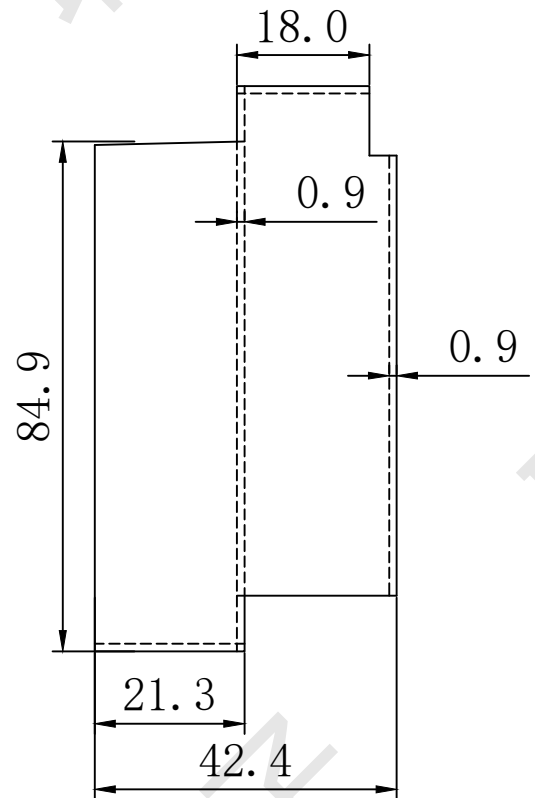
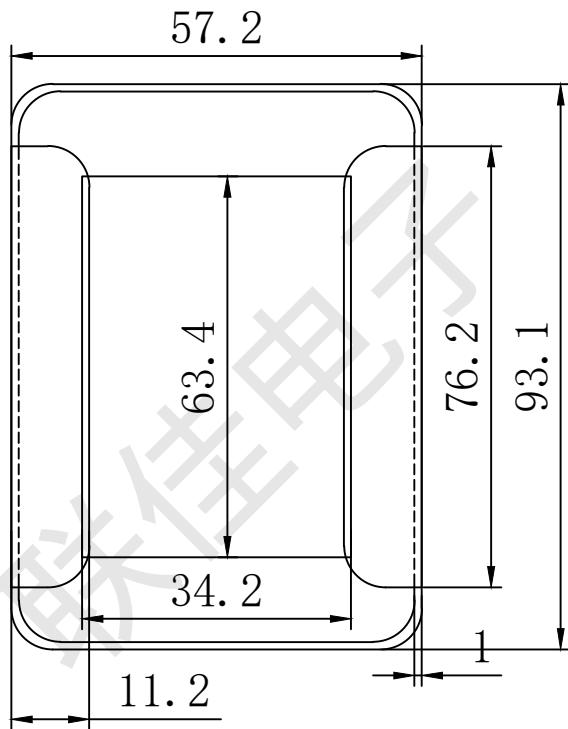
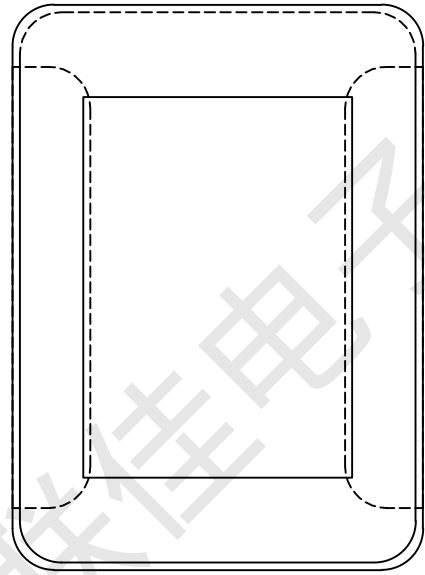
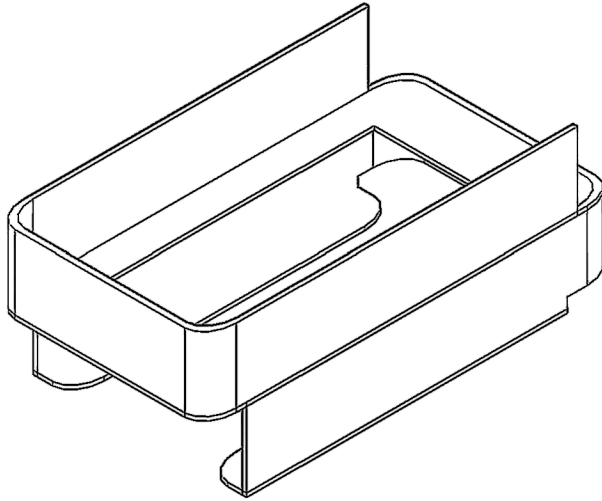

编号: 18655T01		SCALE:	TDLERANCE UNLESS OTHERWISE STATED	CHECK
BOBBIN SIZE:EI-86×55 VDE 套		UNIT:mm	0<L≤4 ±0.1	DRAW
MATERIAL:PA66			4<L≤16 ±0.2	REV: DRTE: 01
UL REC:UL94V-2		DRAWING:	16<L≤63 ±0.3	