

东莞市联佳电子塑胶制品有限公司

TEL:0769-86639029

FAX:0769-86639039

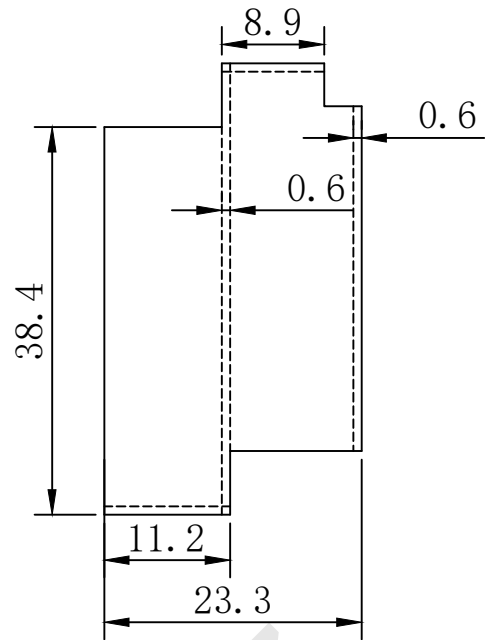
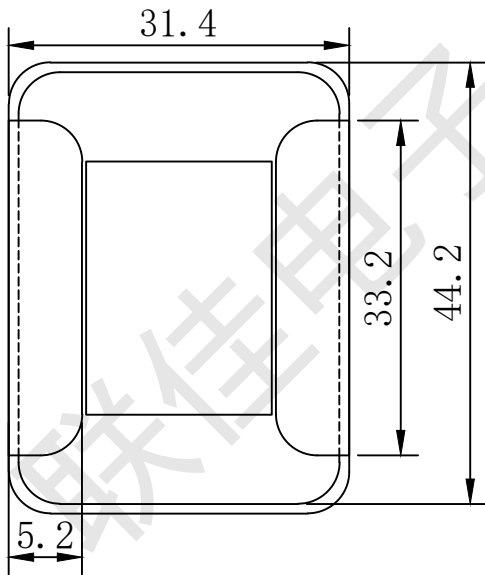
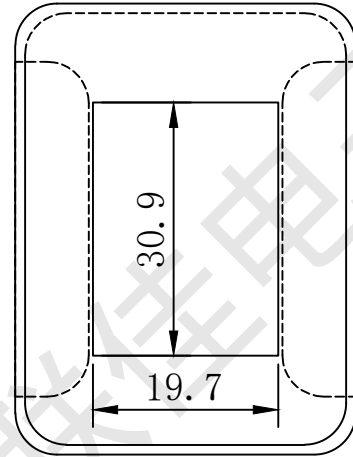
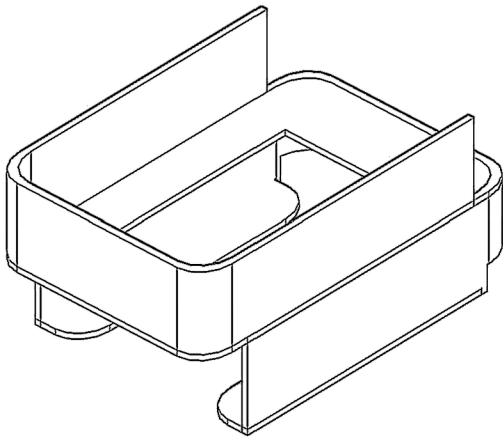

编号: 14824T01		SCALE:	TDLERANCE UNLESS ORHERWISE STATED	CHECK
BOBBIN SIZE:EI-48×24 VDE 套		UNIT:mm	0<L≤4 ±0.1	DRAW
MATERIAL:PN			4<L≤16 ±0.2	
UL REC:UL94V-0		DRAWING:	16<L≤63 ±0.3	REV: 01
				DRTE: